

# SINGLE THROTTLE WITH Two x 6S BATTERIES AND RECEIVER POWERED FROM ESC BEC

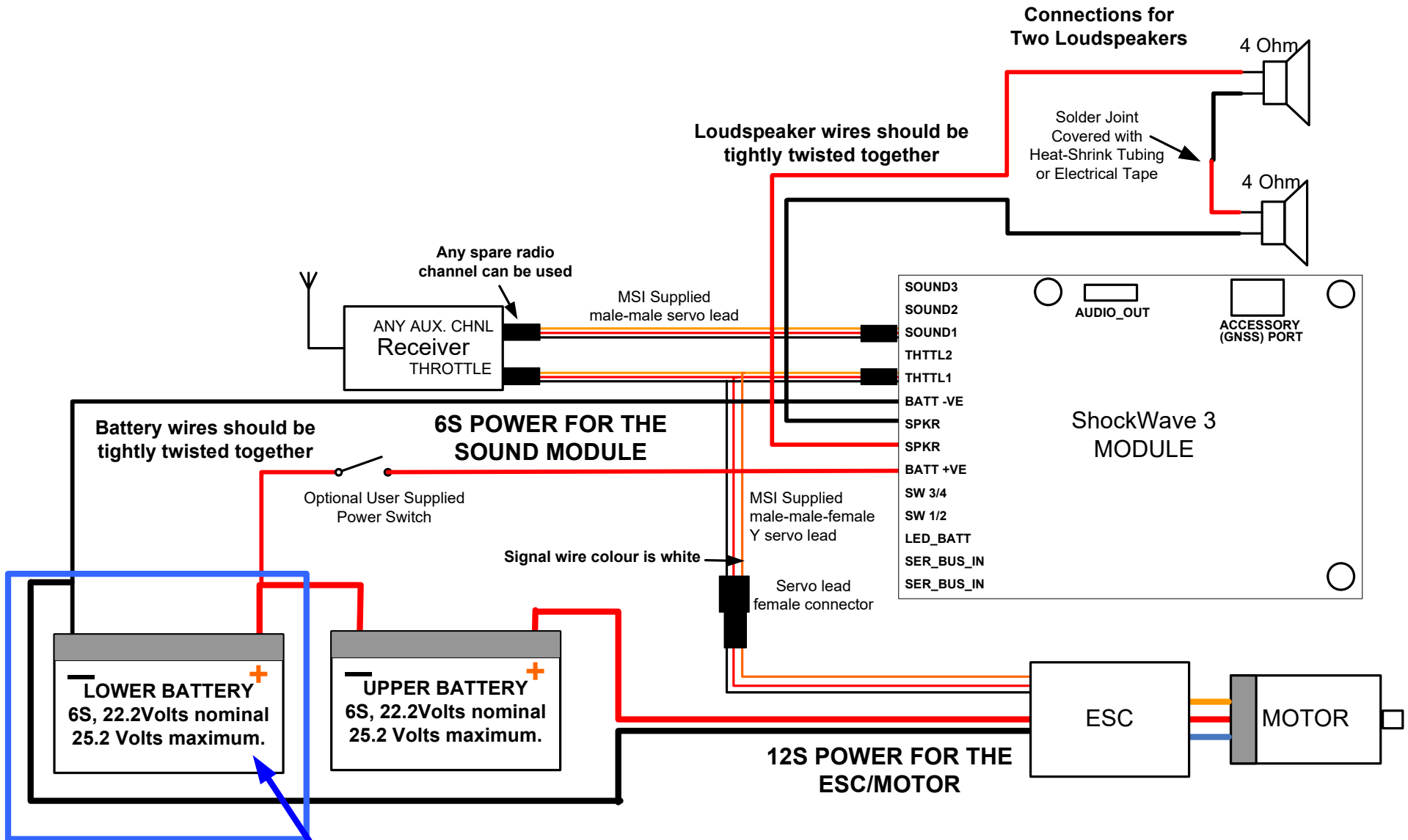

**YOU MUST USE THIS LOWER BATTERY TO POWER THE SOUND MODULE, NEVER THE UPPER ONE!**